

Section 4

This section is separated into two parts as follows.



Section 4a **ORIGINALS**

Key Blanks with the authorized Original Manufacturer's logos and/or designs.



Section 4b **LOOK ALIKE®**

Key Blanks manufactured to look just like the Original Manufacturer's key, without the brand name.

| Look Alike Key Number | Ilco Equivalent | Ilco EZ Equivalent | Fits | Finish | Look Alike Key Number | Ilco Equivalent | Ilco EZ Equivalent | Fits | Finish |
|-----------------------|-----------------|--------------------|-----------------|--------|-----------------------|-----------------|--------------------|------------------|--------|
| 320560 | 1970AM | RA4 | American Motors | NP | 1063KW-BR-250PK | 1176 | KW1 | Kwikset | BR |
| 320561 | S1970AM | RA3 | American Motors | NP | 1063KW-NP-250PK | 1176 | KW1 | Kwikset | NP |
| PTKB1 | 1045 | AM3 | American | BR | N1063KW | 1176 | KW1 | Kwikset | NP |
| CH1C | B1179-1C | - | Arrow | NS | B308 | 1004 | L1 | Lockwood | NP |
| CH1D | B1179-1D | - | Arrow | NS | B310 | 1004A | L4 | Lockwood | NP |
| K2-A | 1179 | AR1 | Arrow | BR | 15K | 1092N | M16 | Master | BR |
| K7 | 1179A | AR4 | Arrow | NS | 1K | 1092 | M16 | Master | BR |
| 1A1A1 | A1114A | BE2 | Best | NS | 1515 | - | - | Medeco | NS |
| 1A1B1 | A1114B | - | Best | NS | 1517 | - | - | Medeco | NS |
| 1A1C1 | A1114C | - | Best | NS | 1518 | - | - | Medeco | NS |
| 1A1D1 | A1114D | - | Best | NS | 1542 | - | - | Medeco | NS |
| 1A1DD1 | A1114DD | - | Best | NS | 1543 | - | - | Medeco | NS |
| 1A1E1 | A1114E | - | Best | NS | 1638 | - | - | Medeco | NP |
| 1A1F1 | A1114F | - | Best | NS | 1644 | - | - | Medeco | NP |
| 1A1FM1 | A1114FM | - | Best | NS | 1655 | - | - | Medeco | NS |
| 1A1G1 | A1114G | - | Best | NS | A1515 | - | - | Medeco | NS |
| 1A1H1 | A1114H | - | Best | NS | A1517 | - | - | Medeco | NS |
| 1A1J1 | A1114J | - | Best | NS | A1638 | - | - | Medeco | NP |
| 1A1K1 | A1114K | - | Best | NS | 4295 | R1064E | NA25 | National | BR |
| 1A1L1 | A1114L | - | Best | NS | 5981R | N1011P | RU52 | Russwin | NS |
| 1A1M1 | A1114M | - | Best | NS | 5D1R | 1011D1 | RU45 | Russwin | NS |
| 1A1Q1 | A1114Q | - | Best | NS | 6D1R | A1011D1 | RU46 | Russwin | NS |
| 1A1R1 | A1114R | - | Best | NS | 275LA | 1007LA | S22 1/2 | Sargent | NS |
| 1A1TA1 | - | - | Best | NS | 275S | 1010N | S68 | Sargent | NS |
| 1A1TB1 | A1114TB | - | Best | NS | 6275LA-NP | 01007LA | S22 | Sargent | NP |
| 1A1WA1 | - | - | Best | NS | 6275LA-NS | 01007LA | S22 | Sargent | NS |
| 1A1WB1 | - | - | Best | NS | 100-C | 1145 | SC1 | Schlage | NP |
| 1A1WC1 | - | - | Best | NS | 100-C-250PK | 1145 | SC1 | Schlage | NP |
| 1A1WD1 | - | - | Best | NS | 100C-BR | 1145 | SC1 | Schlage | BR |
| 1A1WE1 | - | - | Best | NS | 100-C-NS | 1145 | SC1 | Schlage | NS |
| 1A1WG1 | - | - | Best | NS | 100C-NS 250PK | 1145 | SC1 | Schlage | NS |
| 1A1WH1 | - | - | Best | NS | 100-E | 1145E | SC8 | Schlage | NP |
| 1A1WY1 | - | - | Best | NS | 100-E-NS | 1145E | SC8 | Schlage | NS |
| K4 | 1041G | CG1 | Chicago | BR | 101-C | 1145A | SC4 | Schlage | NP |
| K5 | C1041P | - | Chicago | BR | 101C-BR | 1145A | SC4 | Schlage | BR |
| 320433 | S1768CH | - | Chrysler | NP | 101C-BR-250PK | 1145A | SC4 | Schlage | BR |
| 320514 | 1769CH | - | Chrysler | NP | 101-CE-NS | A1145CE | - | Schlage | NS |
| Z1-59A1-6 | A1001AH | CO91 | Corbin | NS | 101-C-NS | 1145A | SC4 | Schlage | NS |
| Z1-59A2-6 | A1001FH | CO92 | Corbin | NS | 101C-NS 250PK | 1145A | SC4 | Schlage | NS |
| Z1-59B1-6 | A1001BH | CO94 | Corbin | NS | 101-E | A1145E | SC9 | Schlage | NP |
| Z1-59B2-6 | A1001DH | CO95 | Corbin | NS | 101-EF-NS | A1145EF | - | Schlage | NS |
| Z1-59C1-6 | A1001C1 | CO98 | Corbin | NS | 101-E-NS | A1145E | SC9 | Schlage | NS |
| Z1-59C2-6 | A1001C2 | CO102 | Corbin | NS | 101E-NS 250PK | A1145E | SC9 | Schlage | NS |
| Z1-59D1-6 | A1001D1 | CO107 | Corbin | NS | 101-F | A1145F | SC10 | Schlage | NP |
| Z1-59D2-6 | A1001D2 | CO108 | Corbin | NS | 101-F-NS | A1145F | SC10 | Schlage | NS |
| Z1-60-5 | 1001EH | CO87 | Corbin | NS | 180A | 1307A | SC6 | Schlage | NP |
| Z1-60-6 | A1001EH | CO88 | Corbin | NS | 200W | 1307W | SC22 | Schlage | NP |
| 67 | D1054K | DE6 | Dexter | BR | K9 | 1120D | SL1 | Segal | BR |
| S54F | - | - | Dominion | NP | 83559 | A1176ST | KW10 | Titan | NP |
| KB1577G | A1054WD | FA3 | Falcon | NS | 08260KW | A1176ST | KW10 | Titan | NS |
| P1577E | A1054WC | FA2 | Falcon | NS | 07743 | - | - | Titan (Lg. Head) | NP |
| 00113 | 1167FD | H51 | Ford | NP | 13D | VR91AR | VR7 | Viro | NP |
| 00114 | S1167FD | H50 | Ford | NP | 15D | VR91AR | VR2 | Viro | NP |
| 00116 | 1184FD | H54 | Ford | NP | 1555 | 1054WB | WR3 | Weiser | NP |
| GM-A | P1098A | B48 | GM | NP | 1555-NP-250PK | 1054WB | WR3 | Weiser | NP |
| GM-B | S1098B | B49 | GM | NP | 1555-NS | 1054WB | WR3 | Weiser | NS |
| GM-C | P1098C | B50 | GM | NP | P1555 | N1054WB | WR5 | Weiser | NP |
| GM-D | S1098D | B51 | GM | NP | P1555-BR-250PK | N1054WB | WR5 | Weiser | BR |
| GM-E | P1098E | B44 | GM | NP | P1555-NS | N1054WB | WR5 | Weiser | NS |
| GM-H | S1098H | B45 | GM | NP | 12344 | 1175N | WK2 | Weslock | BR |
| GM-J | P1098J | B46 | GM | NP | 12344-NS | 1175N | WK2 | Weslock | NS |
| GM-K | S1098K | B47 | GM | NP | 8 | 999 | Y1 | Yale | BR |
| HARLOC | X1014F | EA27 | Harloc | BR | 9114 | 01122 | Y11 | Yale | BR |
| H20 | 1003M | CO106 | Hudson | BR | 9278 | 01122A | Y12 | Yale | BR |
| H21 | R1003M | BO1 | Hudson | BR | 8 YALE-250PK | 999 | Y1 | Yale | BR |
| 1063KW | 1176 | KW1 | Kwikset | NP | E8 | 999N | Y1E | Yale | BR |
| 1063KW-BR | 1176 | KW1 | Kwikset | BR | | | | | |

GM

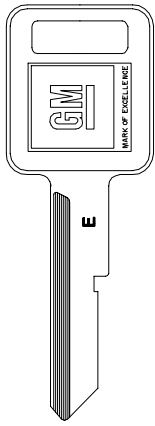

B46G

B48G

B50G

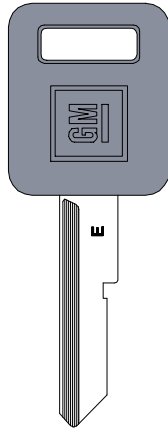

B48GP

B50GP

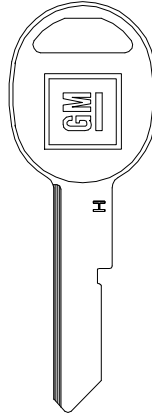

B47G

B49G

B51G

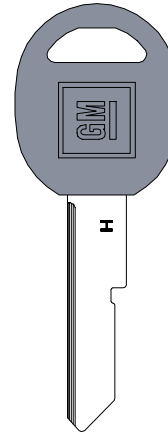

B49GP

B51GP



B44G



B44GP



B45G



B45GP

ILCO

GM

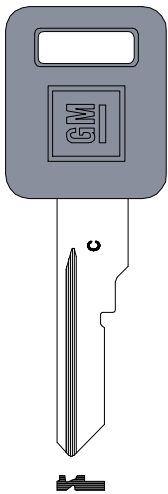

B63GP

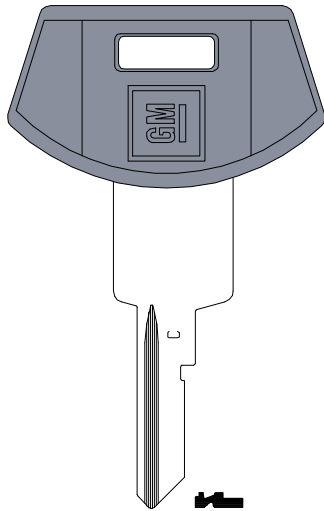

B64GP

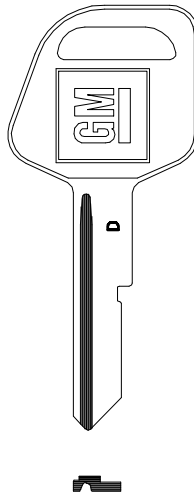

B67G

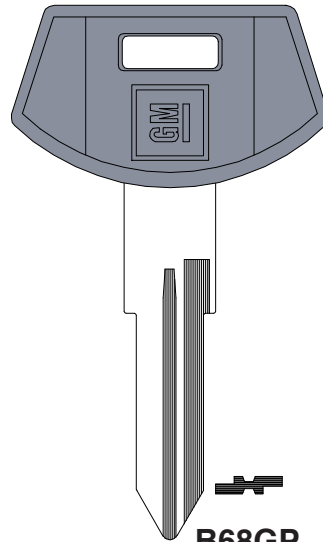

B68GP

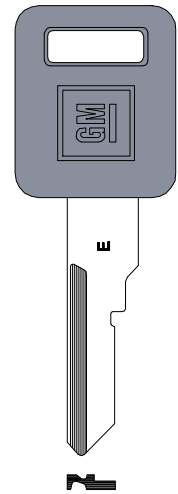

B77GP

ILCO

GM

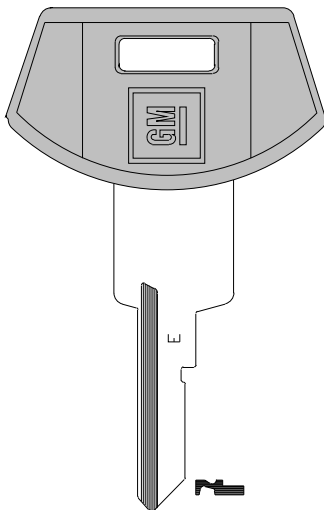

B78GP

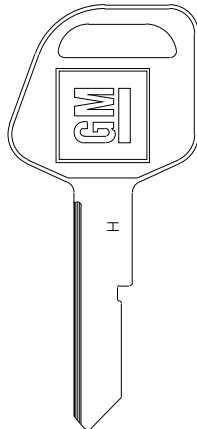

B79G

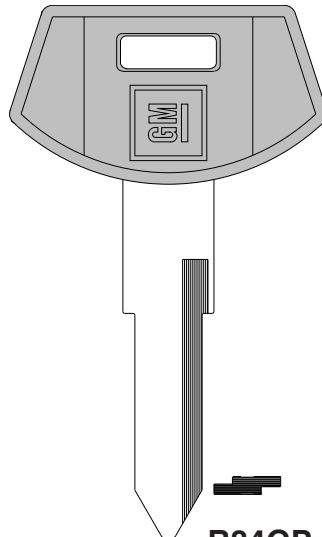

B84GP

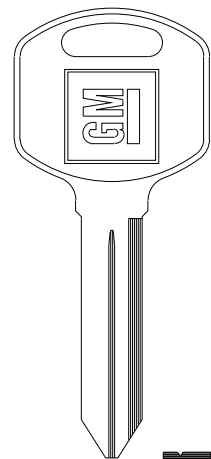

B85G

ILCO

GM

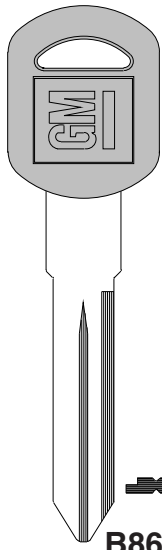

B86GP

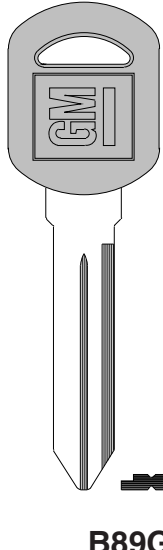

B89GP

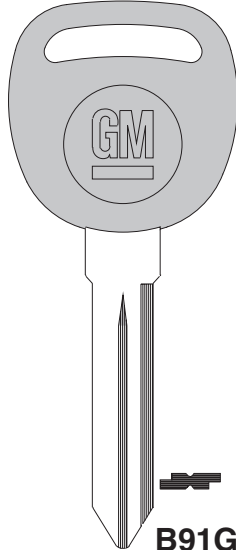

B91GP

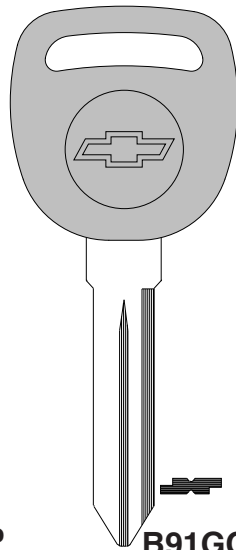

B91GCP

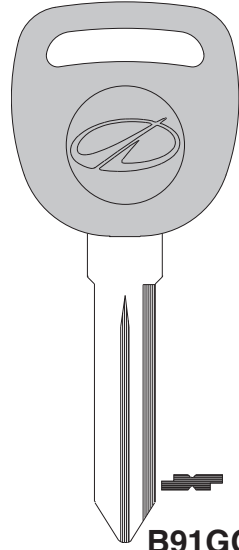

B91GOP

ILCO

GM

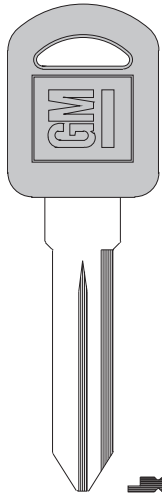

B92GP

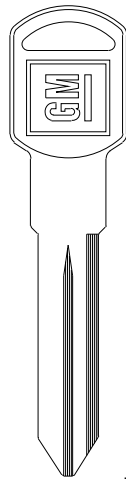

VALET FOR B92GP

B92GV

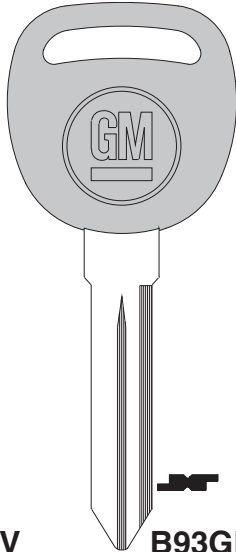

B93GP

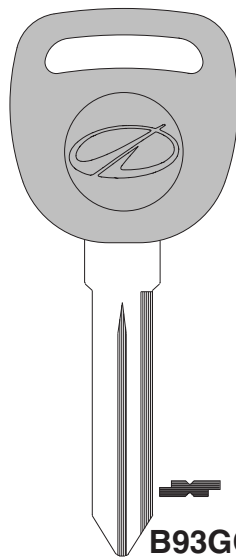

B93GOP

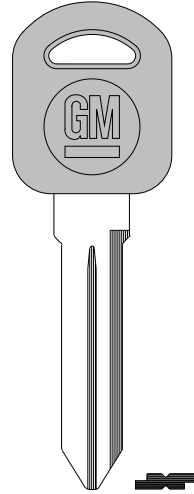

B97GPT

ILCO

GM

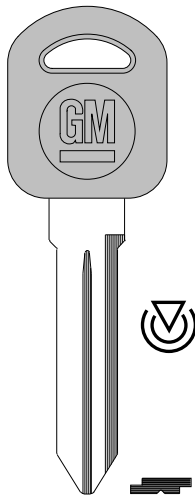

B98GPT

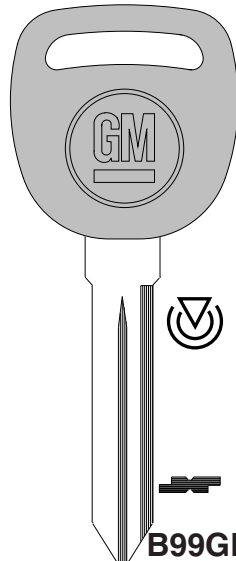

B99GPT

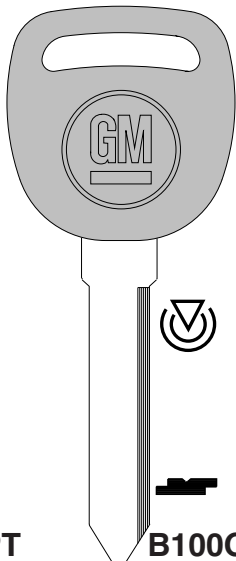

B100GPT

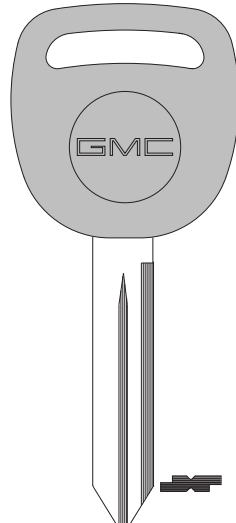

B102GP

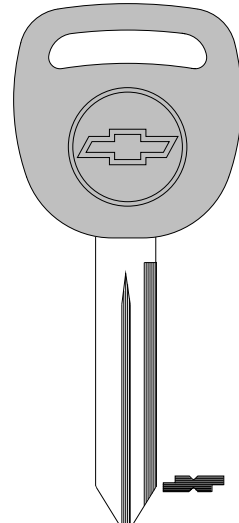

B102GCP

ILCO

GM

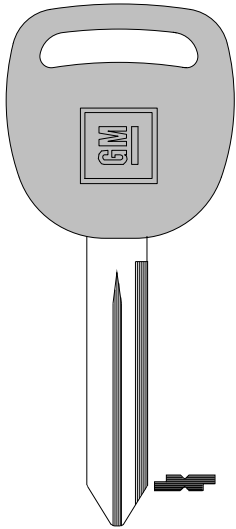

B102GMP

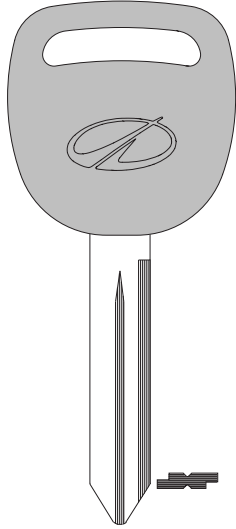

B102GOP

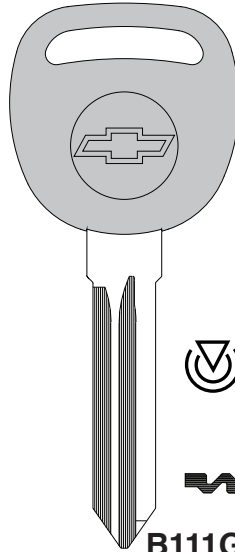

B111GCPT

ILCO

ORIGINALS

sec page
4a 3

ILCO

KWIKSET



10119-001

ILCO

AMERICAN LOCK

ARROW

BEST

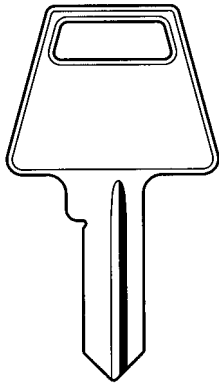

PTKB1

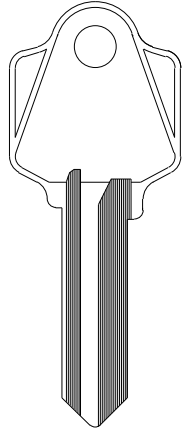

K2-A

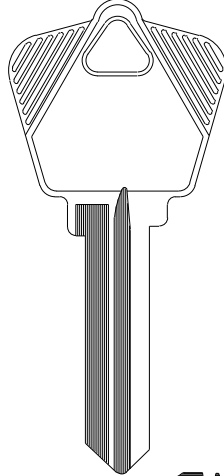

K7
NICKEL SILVER

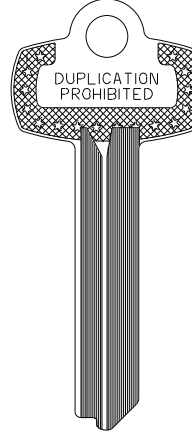

1A1A1
NICKEL SILVER

- | | | | |
|--|--------|--|--------|
| | 1A1B1 | | 1A1J1 |
| | 1A1C1 | | 1A1K1 |
| | 1A1D1 | | 1A1L1 |
| | 1A1DD1 | | 1A1M1 |
| | 1A1E1 | | 1A1Q1 |
| | 1A1F1 | | 1A1R1 |
| | 1A1G1 | | 1A1FM1 |
| | 1A1H1 | | |

Orig. No.

BEST

CHICAGO

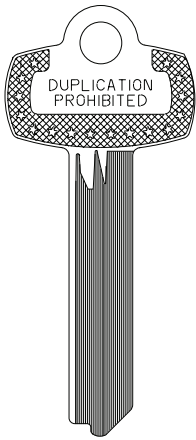

1A1T1
NICKEL SILVER

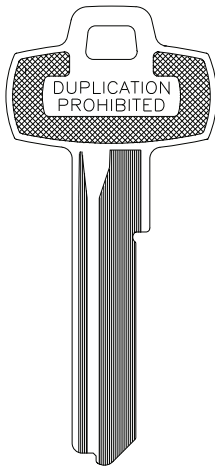

1A1WA1
NICKEL SILVER

- | | | | |
|--|--------|--|--------|
| | 1A1WB1 | | 1A1WC1 |
|--|--------|--|--------|

- | | | | |
|--|--------|--|--------|
| | 1A1WD1 | | 1A1WE1 |
|--|--------|--|--------|

- | | | | |
|--|--------|--|--------|
| | 1A1WG1 | | 1A1WH1 |
|--|--------|--|--------|

- | | |
|--|--------|
| | 1A1WY1 |
|--|--------|

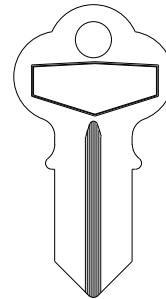

K4

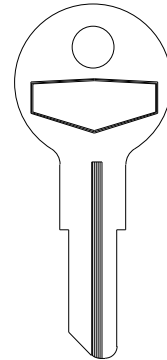

K5

Orig. No.

CORBIN (now Corbin/Russwin)

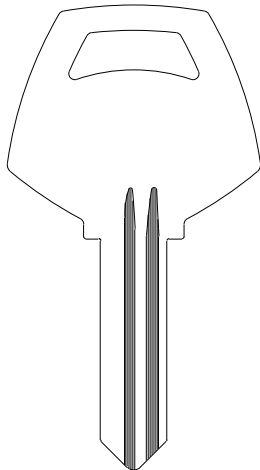

W4-59A1-6
NICKEL SILVER

- | | |
|--|-----------|
| | W4-59A2-6 |
| | W4-59B1-6 |
| | W4-59B2-6 |
| | W4-59C1-6 |
| | W4-59C2-6 |
| | W4-59D1-6 |
| | W4-59D2-6 |

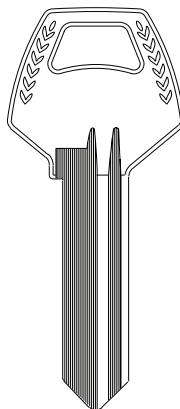

Z1-59A1-6
NICKEL SILVER

- | | |
|--|-----------|
| | Z1-59A2-6 |
| | Z1-59B1-6 |
| | Z1-59B2-6 |
| | Z1-59C1-6 |
| | Z1-59C2-6 |
| | Z1-59D1-6 |
| | Z1-59D2-6 |

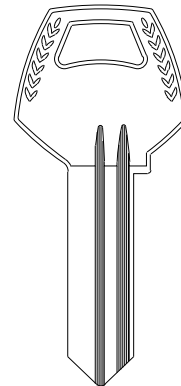

Z1-60-5
NICKEL SILVER

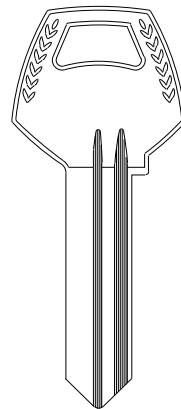

Z1-60-6
NICKEL SILVER

Orig. No.

LOOK ALIKE®

| | DEXTERMMASTER | DOMINION | FALCON | | HARLOC | HUDSON |
|-----------|---------------|----------|-------------------------|--------------------------|--------|--------|
| | | | | | | |
| Orig. No. | 67 | S54F | P1577E NICKEL SILVER | KB1577G NICKEL SILVER | HARLOC | H20 |

| | HUDSON | KWIKSET | | | |
|-----------|--------|---------|-----------|---------|-------|
| | | | | | |
| Orig. No. | H21 | 1063KW | 1063KW-BR | N1063KW | 07743 |

| | KWIKSET/TITAN | LOCKWOOD | | MASTER | |
|-----------|---------------|----------|------|--------|-----|
| | | | | | |
| Orig. No. | 08260KW | B308 | B310 | 1K | 15K |

LOOK ALIKE®

sec 4b page 2

MEDECO®

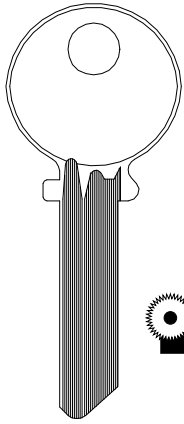

1515

NICKEL SILVER

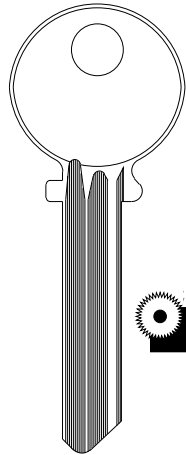

A1515

NICKEL SILVER

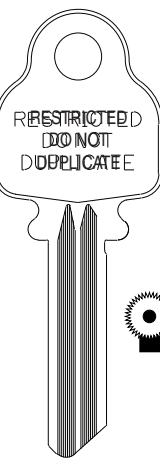

1517

NICKEL SILVER

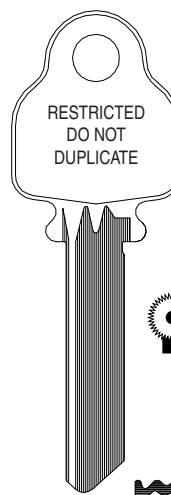

A1517

NICKEL SILVER

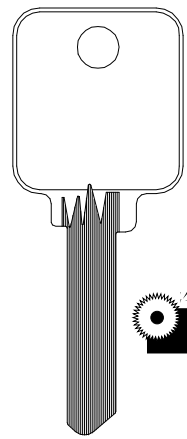

1518

NICKEL SILVER

Orig.
No.

MEDECO®

NATIONAL/AMEROCK

RUSSWIN

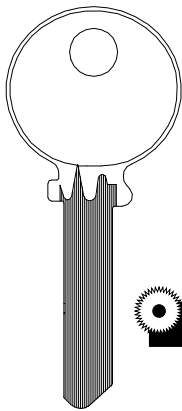

1542

NICKEL SILVER

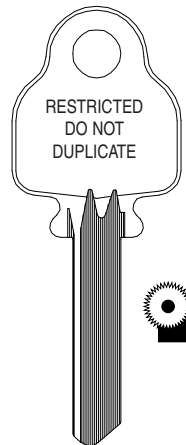

1543

NICKEL SILVER

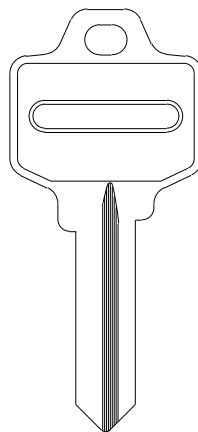

4295

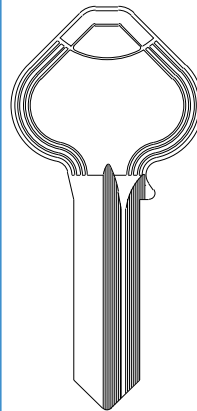

5D1R

NICKEL SILVER

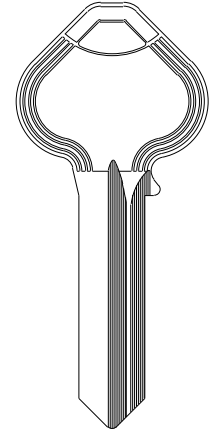

6D1R

NICKEL SILVER

Orig.
No.

SARGENT

SCHLAGE

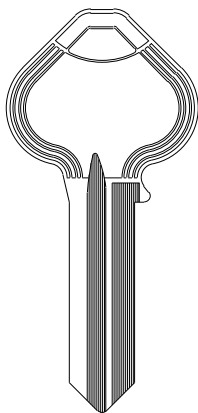

5981R

NICKEL SILVER

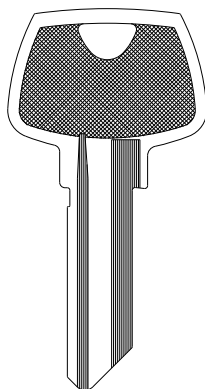

275S

NICKEL SILVER

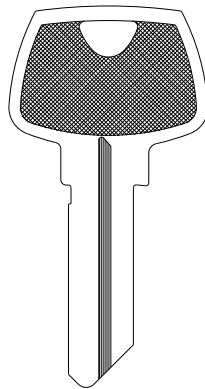

275LA

NICKEL SILVER

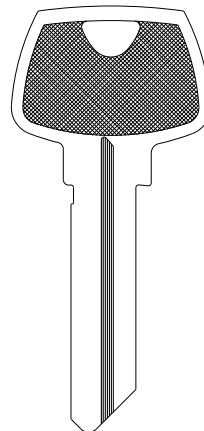

6275LA

NICKEL SILVER

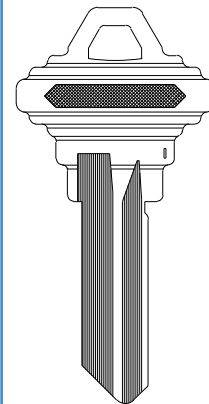

100-C

100C-NS

Orig. No.

LOOK ALIKE®

sec 4b page 3

SCHLAGE

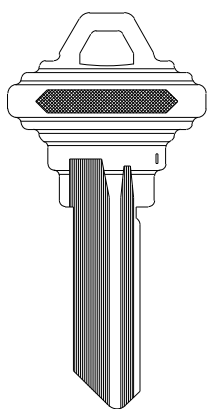

100-E
100E-NS

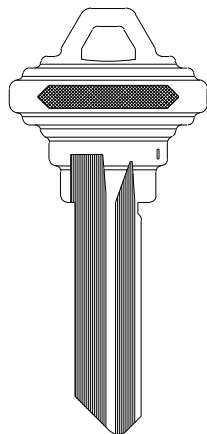

101-C
101C-NS

101E
101E-NS

101CE-NS

101EF-NS

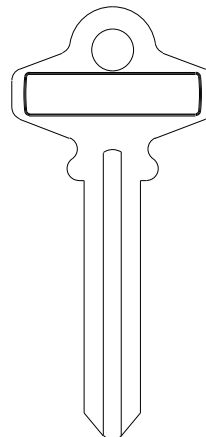

180A

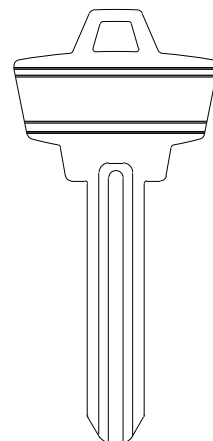

200W

Orig. No.

SEGAL

TITAN

VIRO

WEISER

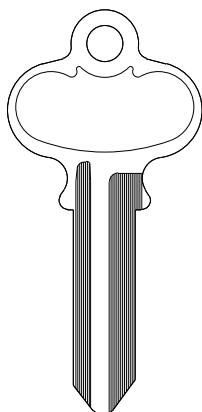

K9

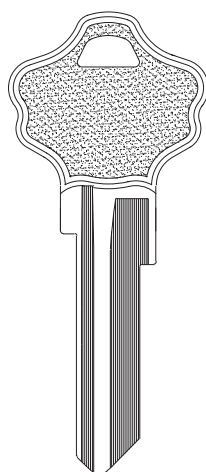

83559

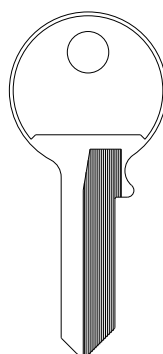

13D

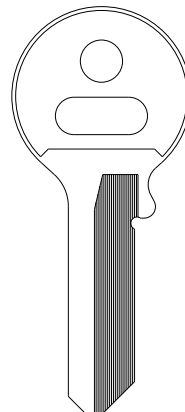

15D

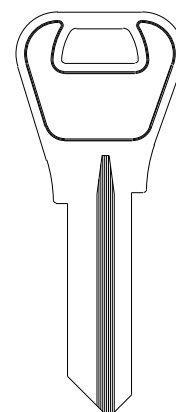

1555
1555-NS

Orig. No.

WEISER

WESLOCK

YALE

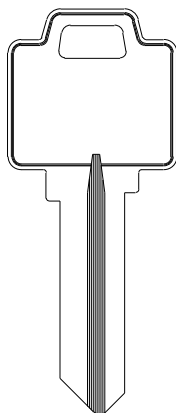

P1555
P1555-NS

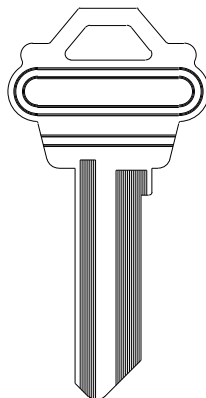

12344
12344-NS

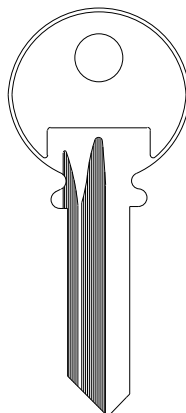

8
8-YALE-NS

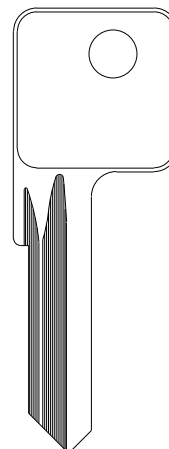

E8

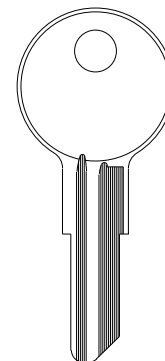

9114

Orig. No.

LOOK ALIKE®

sec page
4b 4

| YALE | AMERICAN MOTORS | | CHRYSLER | FORD | |
|------|-----------------|--------|----------|--------|-------|
| | | | | | |
| | | | | | |
| 9278 | 320560 | 320561 | 320514 | 320433 | 00113 |

Orig. No.

| FORD | | GENERAL MOTORS | | |
|-------|-------|----------------|------|------|
| | | | | |
| | | | | |
| 00114 | 00116 | GM-A | GM-B | GM-C |

Orig. No.

| GENERAL MOTORS | | | | |
|----------------|------|------|------|------|
| | | | | |
| | | | | |
| GM-D | GM-E | GM-H | GM-J | GM-K |

Orig. No.

LOOK ALIKE®