

STANLEY[®]
Security Solutions

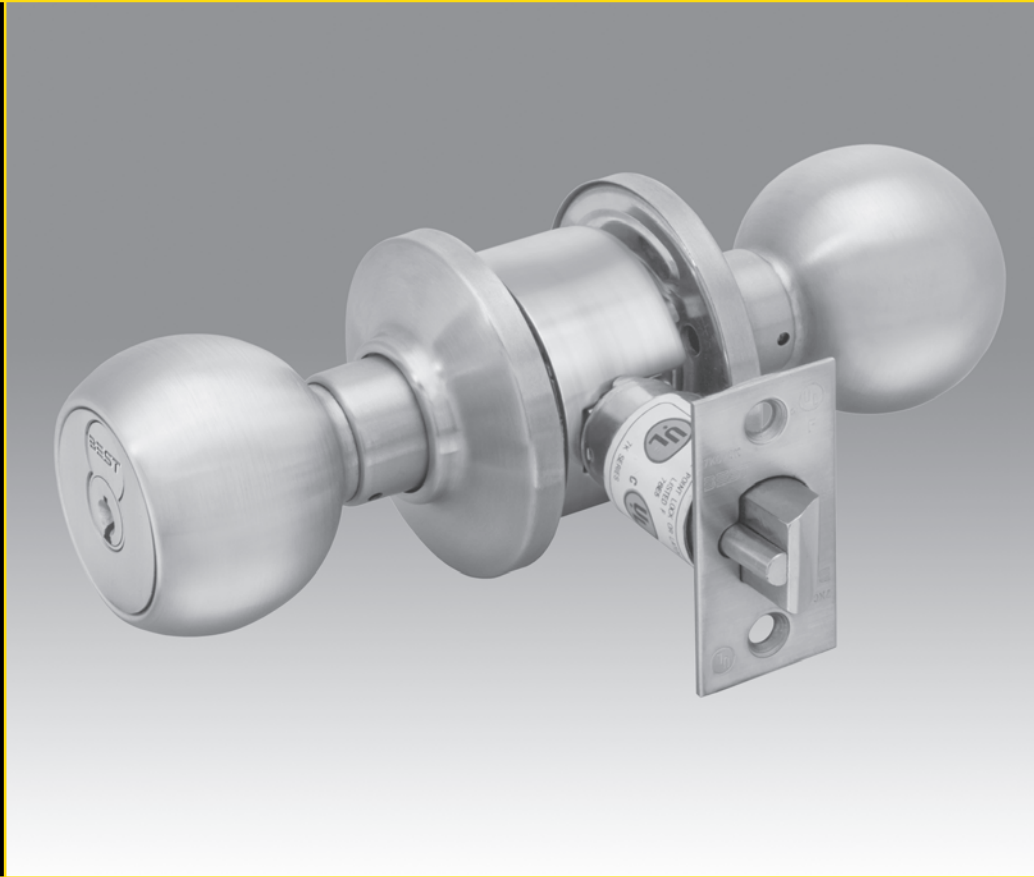

6K SERIES

MEDIUM DUTY LOCKS - KNOBS



FEATURES

- Quick rekeying by BEST interchangeable core.
- Snap-on inside rose (no exposed mounting screws).
- Threaded outside rose adjustable for door thickness.
- Keyed knob is removable only after removal of core.
- Internal steel mechanisms are corrosion treated for normal atmospheric conditions.
- Lockset reversible for either hand of door without removing keyed knob.
- Listed by Underwriters Laboratories for use on 3 hour, A label single swinging doors (4' x 8'). GYJT Builders Hardware-Single point Locks or Latches.
- ANSI/BHMA LISTED - This product is listed in BHMA Directory of Certified Locks and Latches as conforming to ANSI A156.2, Series 4000, Grade 2. (formerly FF-H-106C Series 160)



6K – #4 Round Knob



6K – #6 Tulip Knob



Products protected by one or more of the following patents:

	<u>U.S.A.</u>		<u>CANADA</u>
4,428,570	4,843,852	4,435,967	1,194,057
5,232,255	5,590,555	5,794,472	1,196,359
D,290,085			Other patents pending

When a heavy duty knob lockset is required, our 8K heavy duty series is recommended.







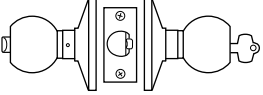
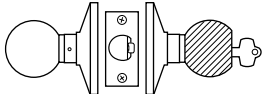
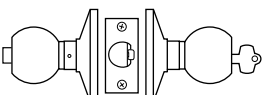

SPECIFICATIONS

- Backset:** 2 3/8" for 62K Series; 2 3/4" for 63K Series; 3 3/4" for 64K Series; 5" for 65K Series.
- Case:** 2 1/16" Dia. cylindrical, for 2 1/8" hole.
- Finish:** Standard finishes are 605, 606, 611, 612, 613, 625, 626. Split finish is available.
- Interchangeable core:** Solid brass, pin-tumbler type in knob with 7-pin core.
- Knobs:** 2" or 2 1/8" Dia. brass or bronze in round or tulip style.
- Latch:** 1/2" throw deadlocking latch. Front: 2 1/4" x 1" x 5/32" Standard for 62K. (Optional for 63K), 2 1/4" x 1 1/8" x 5/32" Standard for 63K (Optional for 62K).
- Lock and latchsets:** Sets consist of latch complete with trim. Type and operation according to set number. Set also includes interchangeable core and two nickel silver keys, keyed to your system.
- Material:** Component parts include brass or bronze. Internal parts are brass or zinc dichromate steel.
- Mounting:** 2 1/8" Dia. bore for lock housing, 1" Dia. or 7/8" Dia. for latch tube.
- Options:** KNL– Knurl keyed knob, L8– drive in-latch.
- Roses:** C– 2 9/16" Dia. D– 3 3/8" Dia. Mounting screws concealed.
- Strike:** STK (standard)– 2 3/4" x 1 1/8" with curved lip & box (ANSI A115.2 for 1 3/8" doors). S3– 4 7/8" x 1 1/4" with curved lip and box (ANSI A115.2 for 1 3/4" doors).
- Thickness of doors:** 1 3/8" to 1 7/8" Standard. If thickness is greater, use our heavy duty locksets for specified door thickness.

HOW TO ORDER

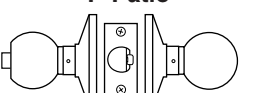
63K	7	AB	4	C	STK	626	
Backset	Core Housing	Function Code	Knob Style	Trim Style	Strike Package	Standard Finishes	Options
62K– 2 3/8" 63K– 2 3/4" 64K– 3 3/4" 65K– 5"	0– keyless 7– 7-pin housing accepts all Best cores	AB– entrance D– storeroom L– privacy N– passage R– classroom etc.	4– round 6– tulip	C– 2 9/16" D– 3 3/8"	STK– standard S3– ANSI	605 606 611 612 613 625 626	KNL– knurled knobs (available on #4 & #6 keyed knobs only) L8– drive in-latch (available on 62K & 63K only)



Function & Diag. (ANSI No.)	Description	Outside Knob		Inside Knob	
		Latch operated by	Locked by	Unlocked by	Locked by
Single Keyed					
 <p>AB-Entry F109 (F81xF82)</p>	<ul style="list-style-type: none"> Rotating inside knob, Rotating outside knob only when outside knob unlocked Turning key in outside knob 	<ul style="list-style-type: none"> Pushing the inside button Pushing and turning inside button keeps outside knob locked until the button is turned back 	<ul style="list-style-type: none"> Having button in vertical position and turning key, Turning inside knob Closing door 	Cannot be locked	Always unlocked
 <p>D-Storeroom F86</p>	<ul style="list-style-type: none"> Turning key in outside knob, Rotating inside knob 	Always locked	Cannot be unlocked	Cannot be locked	Always unlocked
 <p>E-Service Station F92</p>	<ul style="list-style-type: none"> Rotating inside knob, Rotating outside knob only when inside slotted push button is out, Turning key in outside knob 	<ul style="list-style-type: none"> Pushing inside button, Pushing and turning inside slotted button <p>Note: Pushing and turning inside slotted button keeps outside knob locked until button is released</p>	<ul style="list-style-type: none"> Having slot in vertical position and turning key in outside knob, Rotating inside knob, Closing the door, only when button is not turned 	Cannot be locked	Always unlocked
 <p>L-Privacy F76</p>	<ul style="list-style-type: none"> Rotating inside knob, Rotating outside knob only when outside knob is unlocked 	Pushing inside button	<ul style="list-style-type: none"> Turning inside knob, Turning emergency outside slot, Closing door 	Cannot be locked	Always unlocked
 <p>LL-Hospital Privacy</p>	<ul style="list-style-type: none"> Rotating inside knob, Rotating outside knob when unlocked 	Pushing in button on inside knob	<ul style="list-style-type: none"> Rotating inside knob, Closing door, Turning turn button in outside knob 	Cannot be locked	Always unlocked
 <p>N-Passage F75</p>	<ul style="list-style-type: none"> Rotating inside knob, Rotating outside knob 	Cannot be locked	Always unlocked	Cannot be locked	Always unlocked
 <p>P-Patio F77</p>	<ul style="list-style-type: none"> Rotating inside knob, Rotating outside knob when unlocked 	Pushing in button on inside knob	<ul style="list-style-type: none"> Turning inside knob, Closing door 	Cannot be locked	Always unlocked
 <p>R-Classroom F84</p>	<ul style="list-style-type: none"> Rotating inside knob, Turning key in outside knob, when outside knob is locked, Rotating outside knob when not locked by key 	Turning key in outside knob	Turning key in outside knob	Cannot be locked	Always unlocked
 <p>Y-Exit</p>	Rotating the inside knob	No outside knob - Blank rose	No outside knob - Blank rose	Cannot be locked	Always unlocked
 <p>1DT-Single Dummy Trim</p>	This is a single, surface-mounted knob for an inactive or a non-latching door.				
 <p>2DT-Double Dummy Trim</p>	This is a through-bolt mounted pair of matching knobs for an inactive or a non-latching door.				

STRIKES & DOOR PREPARATION



STK Strike
(Supplied Standard)

Dimension: Conforms to ANSI 115.2 for 1 3/8" doors (2 3/4" x 1 1/8" with curved lip and box)

To order with lockset:
Designate "STK"

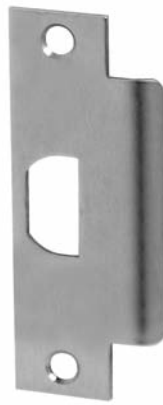

S3 Strike
(ANSI Strike)

Dimension: Conforms to ANSI 115.2 for 1 3/4" doors (4 7/8" x 1 1/8" with curved lip)

To order with lockset:
Designate "S3"

CORMAX™ PATENTED KEYING SYSTEM

One of the greatest threats to key control within your facility is the unauthorized duplication of keys; one simple solution is the use of the CORMAX™ Patented Keying System.

Very seldom can a single product meet all of your exact needs, and often your level of convenience must be sacrificed to fit the capabilities of the product. The CORMAX Patented Keying System provides you with a significant amount of flexibility, enabling a solution that fits your unique balance between security and convenience.

The CORMAX Patented Keying System is available in two series of keyways, the M Series and the X Series. Each series offers a different blend of features. For example the CORMAX Patented Keying System can provide geographic exclusivity to the customer to help you maximize convenience while optimizing your security.



CORMAX™
Patented Keying System

M Series Keyway Features

- Patented keys operate both CORMAX and Standard BEST cores (backward compatibility) with existing BEST keyway (J,K,L,M only). Standard keys do not operate CORMAX cores.
- Available in large bow, long blade, and long nose key blanks to work with special applications.
- Available in core designs for use in special application locks, such as high security mortise, hotel cylinders, and glass display-case locks.
- Utilizes the same combining kits and key cutting equipment as the Standard BEST keyways.
- M Series keys operate CORMAX cores and Standard (non-patented) BEST cores. Standard key blanks do not operate CORMAX cores.

X Series Keyway Features

- Distinctive key design includes thicker key blanks with larger bow for added strength and easier handling.
- Keyways are unique to CORMAX Patented Keying System offering even higher key duplication protection.
- CORMAX keyways utilize the standard combining kit, minimizing the expense of system changeover.
- X Series keys operate CORMAX cores only.

STANLEY

Security Solutions

Stanley Security Solutions, Inc.

6161 E. 75th Street Indianapolis, Indiana 46250

© 2010 Stanley Security Solutions, Inc. • www.stanleysecuritysolutions.com

10M R310
BAS011